

User Manual Revision 3.001

English

Smart energy meter

OB415 Series



www.owen-brothers.com

Benefits and Main Features

- Single phase metering 4 din modules.
- Standard DIN rail Format (DIN43880)
- Cl.1 Accuracy (ENS0470)
- Isolate pulse output and IR (DIN43864)
- Energy Consumption LED & Reverse Current LED
- Communication LED
- LCD display, 6 integer 2 decimal,
- Large clear display with backlight
- Internal transformer
- Direct metering up to 100A
- RS485 communication port, Modbus RTU.
- IR port
- Program by button on the name plate
- Memory back-up (EEPROM)
- CE Approved
- MID approved. Annex B & D

★ The meter is intended to be installed in a Mechanical Environment 'M1', with Shock and Vibrations of low significance, as per 2004/22/EC Directive and should be installed in Electromagnetic Environment 'E2', as per 2004/22/EC Directive.

| <u>Model Number</u> | <u>Communication output</u> |
|---------------------|--------------------------------------|
| OB415-S | Pulse Output |
| OB415-Mb | Pulse Output & M-bus |
| OB415-MOD | Pulse Output, IR & RS485 Modbus RTU. |

Index:

1. Safety notice
2. Content of delivery
3. Technical description
 - 3.1 Model / Part numbers
 - 3.2 Performance criteria
 - 3.3 Meter specification
4. Dimensions and sealing points
5. Wiring diagrams
6. Meter reading
7. Main functions
 - 7.1 Measuring function
 - 7.2 Display
 - 7.3 Pulse output
 - 7.4 IR (Infrared interface)
 - 7.5 RS485 Communication port
8. Programming
 - 8.1 Password verification
 - 8.2 Baud rate setting
 - 8.3 Address setting
 - 8.4 Password setting
9. Basic errors
10. Technical support
11. Declaration of Conformity

1. Safety notice

PLEASE NOTE: WE SUPPLY THESE METERS ON THE ASSUMPTION THEY WILL BE INSTALLED BY A QUALIFIED ELECTRICIAN FAMILIAR WITH THE INSTALLATION OF METERING EQUIPMENT.

All meters must be installed according to applicable wiring diagram. Incorrect connections to the electricity network will cause major display problems and can cause serious damage to the meter.

Before starting meter operation, it must be ensured local conditions of the energy system are consistent with the meter type and configuration. Make sure that cables (conductors) are not damaged during installation of the meter, not energized and are appropriate for the installation in question.

Capacitors within the meter may still be charged even after disconnection from all energy sources.

2. Content of delivery

Single phase electronic energy meter,
instructions for assembly
ID setting
Baud rate setting
Password setting

3. Technical Description

3.1 Performance criteria

| | |
|--|----------------------------|
| Operating humidity | ≤ 75% |
| Storage humidity | ≤ 95% |
| Operating temperature | -25°C - +55°C (3K6) |
| Temperature | -40°C - +70°C (1K4) |
| International standard | EN50470-3 & IEC62053-21 |
| Accuracy class | Cl.1 |
| Protection against penetration of dust and water | IP51 |
| Insulating encased meter protective | Class D |
| Install place | Indoor meter |
| Connection area main terminals | |
| Current terminals flexible | 1× 0 - 25 mm ² |
| Other terminals flexible | 1× 0 - 2.5 mm ² |

3.2 Meter specification

| | |
|--|-------------------------------|
| Voltage(v) | 230V |
| Operational voltage | 70% ~130% Un |
| -Iref | 10A |
| -Itr | 1A |
| -Imax | 100A |
| -Imin | 0.5A |
| -Ist | 40mA |
| Power consumption of current circuits (VA) | < 0.01 |
| Power consumption of voltage circuits (W) | < 1.3W |
| Frequency (Hz) | 50 / 60 |
| Memory back-up | EEprom |
| Environment resistance to heat and fire | Terminal 960°C Cover 650°C |
| Upper | ABS+PC |
| Lower | ABS+PC |
| Pulse width (ms) | 80 |
| Pulse constant (imp/kWh) | 1600 |
| LED constant | 1600 |
| Width (mm) | 72 |
| Height (mm) | 104.5 |
| Depth (mm) | 60 |

4. Dimensions and sealing points

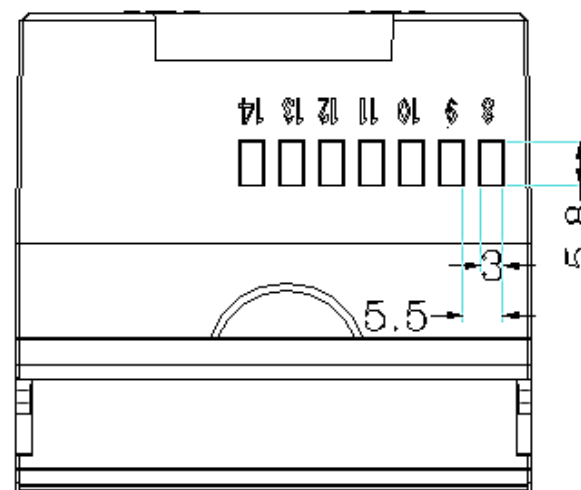
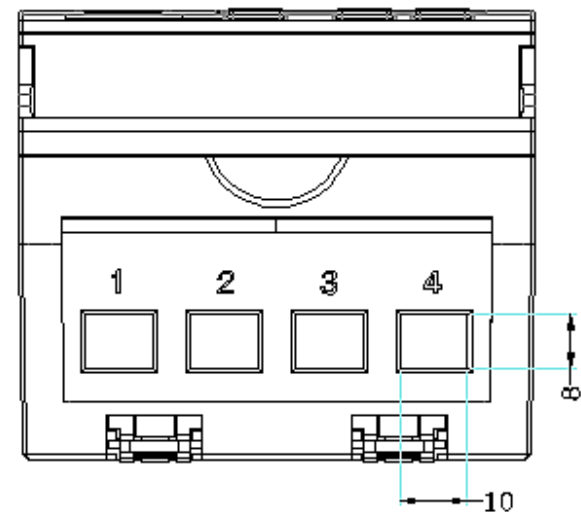
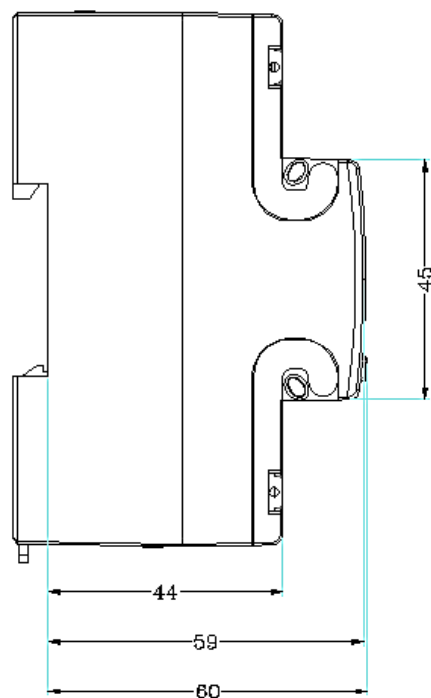
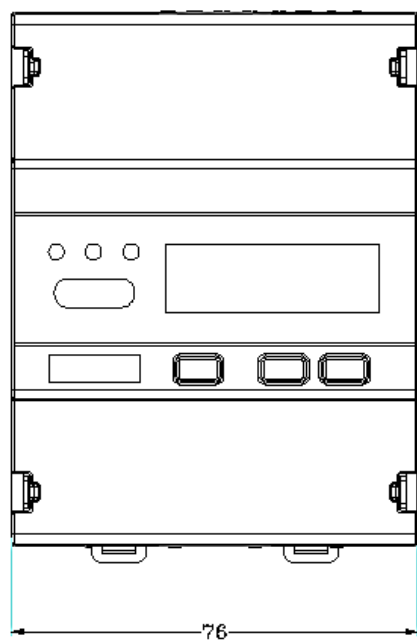



Sealing Points

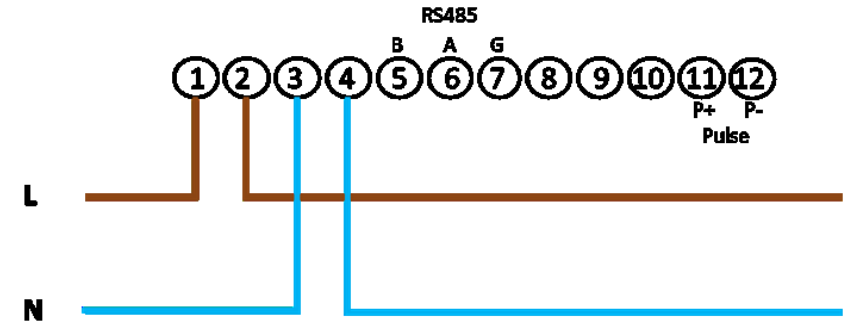

| | | | |
|-------|---------------------------------------|-----|-----------|
| 1/2 | L1 in & Out | | |
| 3/4 | Neutral in & Out | | |
| 5 | RS485 | B | TX/RX (-) |
| 6 | RS485 | A | TX/RX (+) |
| 7 | RS485 | GND | |
| 8 | Not Connected | | |
| 9 | Not Connected | | |
| 10 | Not Connected | | |
| 11/12 | Test pulse output contact (12- , 11+) | | |

5. Wiring Diagram

Note: the following types of wiring diagrams show the energy meter terminals for pulsed output and the RS485 communication interface. However, OB415-S Model is pulse only.

6. Meter reading

Operator viewing angle should be up to 45°

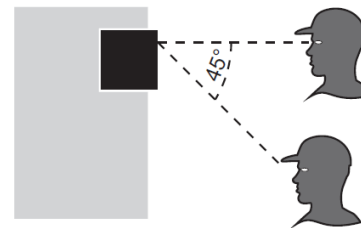

7. Main functions

7.1 Measuring Function

On the OB415'S front panel are three LED's, Active energy pulse, current reverse & communication indicators. The constant of the impulse is shown on the front name plate of the meter.

7.2 Display

The OB415 meter has 3 display cycles, Self-test, auto display cycle & button press cycle.

Upon 1st powerup, the meter will test the display.

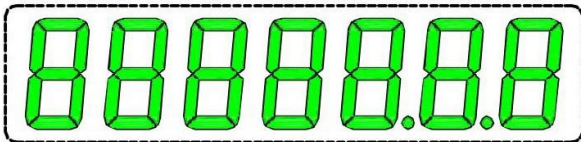

Followed by displaying the meter version number.



After completing the self-test cycle, the meter will switch to auto display cycle and display the following:

Active energy



7.2 Display Continued.

Pressing the buttons on front panel will cycle through the following:
(Models OB415-Mb & OB415-MOD Only)

ID



Serial number
(high bits)



Serial number
(low bits)



Serial number = 00001303019

Baud rate



Active energy



7.3 Pulse output

The OB415 smart meters are equipped with a pulse output which is fully separated from the live circuits.

It generates pulses in proportion to the measured energy including the pulse output of active energy and reactive energy.

11 / 12 Test pulse output contact (P+ / P- 11 / 12)

The test pulse output is a polarity dependent, passive transistor output requiring an external voltage source for correct operation. This external voltage source, the voltage (Ui) should be 5-27v DC, and the maximum input current (Imax) should be 27mA DC.

To connect the impulse output, connect 5-27v DC to connector 12 (anode), and the signal wire (S) to connector 11 (cathode). The meter pulses are indicated on the front panel.

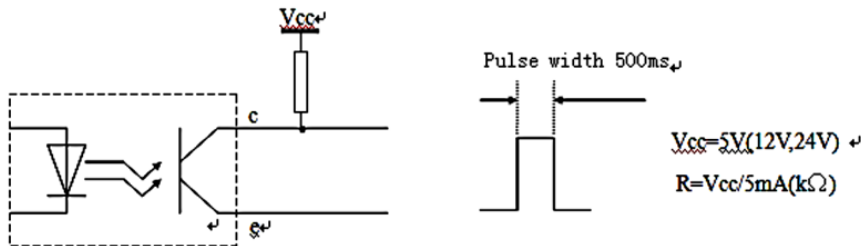

7.4 IR communication (Infrared port)

The infrared communication port is on the right of the LCD. The infrared wireless communication port used with a HHU (hand held unit) can directly communicate the data between the meter and this port. The data transmission speed is 1200bps. The communication distance is maximum 5m.

7.5 RS485 Communication Port.

| | | |
|----------------|-------------------------------|------------|
| RS485 Protocol | OB415-S | None |
| | OB415-MOD | Modbus RTU |
| | OB415-Mb | M-bus |
| Data format | 8 data bits, NONE, 1 stop bit | |
| Baud rate | 1200 ,2400 ,4800 ,9600 | |
| Address range | 1-256 | |
| Bus loading | 64pcs | |
| Cable | AWG 18 | |

8 Programming

Holding the "SET" key pressed for at last 3 seconds starts menu programming mode. LCD shows:

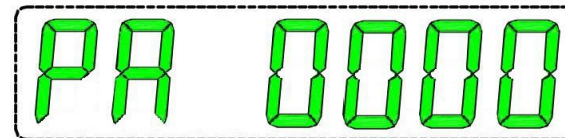

8.2 Password Verify

PA followed by the currently memorized value.

"PA" means "Password", "0000" is the 4 digits to enter the Password. Press ▼ button to decrease the input value, and press ▲ to increase the input value. Press "SET" button to input digit and move to next digit. Once the correct password is entered, the meter will enter programming mode.

--- Please ensure to remember password if altered. ---

8.3 ID Setting

After the password authentication, the meter will display the "ID XX" setup interface. As the following picture "Id 00" it means the current ID address is 00 (the ID slave address hex code)



Press ▼ button to decrease the digits.
Press ▲ button to increase the digits.
press "SET" button to save the setup, the interface will switch to Baud rate setup automatically. Press "SET" to skip to next menu item if no changes are required.

8.4 Baud rate setting

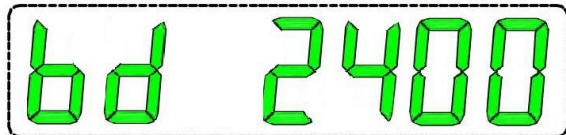

Press ▼ button to decrease the input value.
press ▲ button to increase the input value.
press the "SET" button to confirm.
1. Default baud rate is 9600.
2. 1200/ 2400 / 4800/ 9600 can be selected.

8.5 Password Setting

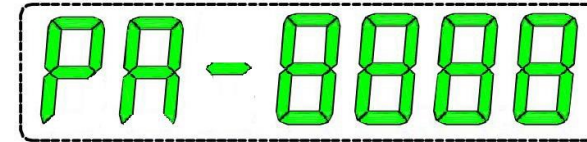

The meter will display the current password after entering the password setup menu, press the "SET" key to change the password. Use ▲ and ▼ button to input new password. After 30 seconds the meter will save the password you chose.

Remarks:

- 1 Do not forget the password that you have setup.
- 2 Press the buttons to check if setup is correct.
- 3 Password setup interface "-" symbol will blink.

9 Basic errors

| Value of current | Power factor | Errors | Test pulse number |
|------------------|--------------|--------|-------------------|
| Imin | 1.0 | ±1.5% | 4 |
| Itr | 1.0 | ±1.0% | 4 |
| Itr | 0.5ind | ±1.5% | 4 |
| Itr | 0.8cap | ±1.5% | 4 |
| 10Itr | 1.0 | ±1.0% | 8 |
| 10 Itr | 0.5ind | ±1.0% | 8 |
| 10Itr | 0.8cap | ±1.0% | 8 |
| Imax | 1.0 | ±1.0% | 12 |
| Imax | 0.5ind | ±1.0% | 12 |
| Imax | 0.8cap | ±1.0% | 12 |

10 Technical Support



New Phoenix Works
Glen Trading Estate
Wellyhole Street
Oldham
United Kingdom
OL4 3BF

Telephone: +44 (0)161 627 6211
Fax: +44 (0)870 622 0424

Sales@owen-brothers.com
Support@owen-brothers.com

www.owen-brothers.com

11 Declaration of Conformity

We, Owen Brothers Metering UK Ltd

www.owen-brothers.com

Ensure and declare that apparatus:

OB415-S/OB415-Mb/OB415-Mod

With the measurement range

230V, 0.5-10(100)A, 50Hz, 1600imp/kWh

Are in conformity with the type as described in the

EC-type examination certificate SGS0202

And satisfy the appropriate requirements of the Directive 2004/22/EC with the following standards:

EN 50470-1: 2006, Electricity metering equipment (AC) Part 1: General requirements, tests and test conditions. Metering equipment (class indexes A, B and C)

And

EN 50470-3: 2006, Electricity metering equipment (AC) Part 3: Particular requirements - Static meters for active energy (class indexes A, B and C)

2 . 9 . 15

Company stamp and signature

Owen Brothers Metering UK Ltd
Unit 6 Glen Trading Estate
Wellyhole Street
OLDHAM OL4 3BF, England