

OB4372

Three phase Power quality meter



Contents

IMPORTANT SAFETY INSTRUCTIONS	1
BENEFITS AND MAIN FEATURES	3
1. TECHNICAL DESCRIPTION	4
1.1 METER SPECIFICATION	4
1.2 MOUNTING	4
1.3 ACCURACY	5
2. SAFETY MEASURES	6
3. OPERATION	7
3.1 INITIALIZATION DISPLAY	7
3.2 SCROLL DISPLAY	7
3.3 CHANGE DEFAULT SETTINGS VIA BUTTONS	10
4. WIRING DIAGRAMS	11
4.1 VOLTAGE/CURRENT TERMINALS	11
4.2 OTHER TERMINALS	11
4.3 RS485 WIRING	12
5. DIMENSIONS	12
6. AVAILABLE MEASUREMENTS	13
7. LOAD SURVEY/PROFILE	14
8. PULSE OUTPUT(Terminals 12, 13 & 15)	14
8.1 WHAT IS PULSE OUTPUT?	14
9. CLEAN	15
10. MAINTENANCE	15
11. DC 5V OUTPUT	15
12.SOLAR PV & RENEWABLES.....	15
13.TECHNICAL SUPPORT	16

Important safety instructions – please read

This document contains important safety instructions. Please read all the instructions and cautionary markings on the product and on any accessories or additional equipment included in the installation. Failure to follow these instructions could result in severe shock or possible electrocution. Always use extreme caution to prevent accidents.

Audience









Installation, maintenance, and connection of electrical equipment must be performed by qualified personnel, in compliance with local electrical standards, wiring rules and the requirements of local power authorities and/or companies. The Owen Brothers Metering strictly conforms to all related safety rules in design and test.

Safety regulations relevant to the location should be followed during installation, operation, and maintenance. Improper operation may cause electric shock, or damage to property, inverter, or equipment.

These instructions are for use by skilled, qualified personnel who:



- Meet all local and governmental code requirements for licensing and training for the installation of electrical power systems with AC and DC voltages up to 600 volts.
- Hold the required qualifications for installing grid-connected systems.
- Have knowledge of the functional principles and operation of grid-connected systems and knowledge of the installation of electrical devices.
- Understand the risk associated with installing and using electrical devices and can implement appropriate risk management strategies.

Symbols used in this manual

SYMBOL	DEFINITION	SYMBOL	DEFINITION	SYMBOL	DEFINITION
	LETHAL DANGER! Risk of electrocution.		DANGER! Risk of electrical shock.		WARNING! Hazard to human life or equipment
	FIRE HAZARD! Follow instructions to avoid.		This product has re-cyclable parts. Dispose of correctly.		Do not dispose as household waste
	Operator's manual; operating instructions				
	Information. The information provided is important for the correct installation, operation and or maintenance of the equipment. Failure to follow the recommendations could result in annulment of the equipment warranty.				PPE. Use appropriate personal protective equipment.

General safety

SYMBOL DEFINITION

- | | |
|--|---|
|  | CAUTION: Equipment damage.
Only use components or accessories recommended or sold by Owen Brothers Metering Technologies or its authorised agents. |
|  | IMPORTANT. Do not attempt to install this equipment if it appears to be damaged in any way. See the Warranty document for instructions on returning the equipment. |

Personal safety

SYMBOL DEFINITION



WARNING: PERSONAL INJURY

- For work safety guidance contact your local WHS authority.
- Use the correct PPE e.g., safety glasses, ear protection, steel-toed safety boots, safety hard hats, etc.
- Use standard safety practices when working with electrical equipment e.g., remove all jewellery, use insulated tools, wear cotton clothing etc.
- Never work alone when installing or servicing this equipment. Have an assistant nearby.
- Ensure that children, pets, and other animals are kept away from the worksite.
- If the equipment is used in a manner not specified by the manufacturer, the protection provided by the equipment may be impaired.



Equipment safety

SYMBOL DEFINITION



WARNING: LETHAL VOLTAGE

- Review the system to identify all possible sources of energy. Ensure all sources of power are disconnected before performing any installation or maintenance on this equipment. Confirm that the terminals are de-energised using a validated voltmeter (rated for a minimum 1000 VAC) to verify the deenergised condition.
- OB4372 contains no user-serviceable parts. Do not dismantle or attempt to repair the equipment. Do not perform any servicing other than that specified in the installation or maintenance instructions unless qualified to do so or have been instructed to do so by Owen Brothers Metering technical support personnel.
- To avoid electric shock, disconnect the AC input of the equipment at least 5 minutes before performing any installation or maintenance.



WARNING: FIRE HAZARD

- Ensure AC, DC and ground cable sizes conform to local codes and are fit for purpose. See product manuals minimum size requirements. Ensure all conductors are in good condition. Do not operate the unit with damaged or substandard cabling.



CAUTION: EQUIPMENT DAMAGE

- Static electricity may damage electronic components. Take proper steps to prevent such damage to the Inverter otherwise the warranty may be annulled.

OB4372

Muti-function, DC 5V, S0,RS485 output

- Modular DIN-rail housing, 4U (72mm Wide)
- Compatible with LV, MV, HV applications
- System wiring method Y/ Δ , Voltage L-L from 208V up to 415V
- More than 300 electrical parameters measured and displayed
- Harmonic analysis of voltage and current up to 41st order
- True RMS measurements (3 phase)
- Phase sequence indication
- Voltage Asymmetry (Phase-Phase, Phase-Neural), Current Asymmetry
- Max & Min & Average & demand measure
- System and phase bidirectional energy
- Programmable load Survey/Profile intervals
- Clock time verification function
- 5V DC output for communication equipment
- LCD display, large clear backlight display for perfect reading
- Monitor energy consumption via S0 Pulse output
- Built-in RS485 communication port, modbus protocol
- The programming switch is protected by lead seal on the upper cover
- Available the remote firmware upgrade of the instrument



Load Profile

THD Up To
41st Order

5V DC Output

System And Phase
Bidirectional Energy

Multi-Measurements

» 1. Technical description

• 1.1 Meter specification

Nominal voltage(Un)	3P4W: 3×120/208V, 3×220/380V, 3×230/400V, 3×240/415V 3P3W: 3×100V, 3×208V, 3×220V, 3×230V, 3×415V
Voltage range(v)	(0.8~1.3)Un
» Current	
- Iref(A)	5
- Itr(A)	0.5
- Imax(A)	65
- Imin(A)	0.25
- Ist(mA)	20
Power consumption of voltage circuits(W)	< 1.3, 6VA
Frequency (Hz)	50/60
Pulse constant(imp/kWh)	1000
Class	B

• 1.2 Mounting

OB4372 Meters are DIN rail mounted as per EN60715 international standards, to mount on DIN rail use a screwdriver to release the lever on the bottom of the meter casing.

A specially designed Panel Mount Adaptor for Standard 92mm x 92mm panel cutout is also available, Please contact sales@owen-brothers.com for further details.



Mounting	On 35mm rail, according to EN60715TH35
Voltage/Current terminals	0 ~ 10mm ² / 2Nm
Another terminals	0.5 ~ 1mm ² /0.2Nm
RS485 cable	AWG18
Ambient temperature	-25°C ~ +55°C (Indoor meter)
Storage temperature	-40°C ~ +70°C (Indoor meter)
Mechanical environment	M1
Electromagnetic environment	E2
Protection against penetration of dust and water	IP51 (frontal part)
Relative humidity	75% without condensation
Protect class	II
Pollution degree	2

• 1.3 Accuracy

Voltage	0.5% of range maximum
Current	0.5% of range maximum
Frequency	0.2% of mid-frequency
Power factor	1% of unity (0.01)
Active power (kW)	± 1% of range maximum
Reactive power (kvar)	± 1% of range maximum
Active energy (kWh)	Class B EN50470-2022
Reactive energy (kvarh)	Class 2 IEC 62053-23

» 2.Safety measures



DANGER! This warning means that a dangerous voltage may be present on the terminals even for short periods.



WARNING! Electrical instrument connections must be carried out only by skilled technicians who are aware of the risks involved to the presence of voltage.

- **Before connecting, check the following:**

1. The conductor wires are not Live.
2. The instrument is connected according to the appropriate diagram.
3. The power supply corresponds to the values on the instrument specification.
4. The instrument has been installed in a vibration-free and a suitable temperature environment.
5. The terminals are no longer accessible after being connected.
6. The wiring is carried out in accordance with the standards in force in the Country where the instrument will be installed.
7. A circuit breaker and an over-current device are installed between the instrument power supply and the electrical system.
8. The connections are made respecting the polarities. Important: L1 of the voltage input = L1 of the ampere metric input.
9. Input and output polarities are respected when using current&voltage transformers, Rogowski coils.
10. The terminals are fixed in such a way that the connection wires cannot be accidentally disconnected.

» 3.Operation

• 3.1 Initialization Display





Full screen, display test
It will last for 2 seconds



Software & Hardware version , CRC verify
It will last for 2 seconds

• 3.2 Scroll display









The buttons operate as follow

	Scroll up the display screen And change the parameter (decrease 1)
	Scroll down the display screen And change the parameter (increase 1)
	Confirm when a parameter has been changed

The meter display items can be configured via RS485. The meter can display max 20 screens in scroll display and 40 screens by button pressing.

Programmable display content as following:

101		102		103		104	
Total active energy LED constant		Import active energy S02 output impulse/kWh		Import active energy of each phase		Export active energy	
105		106		107		108	
Export active energy of each phase		Total active power Total reactive power Total power factor		Total apparent power MD Total active power MD		Instant Phase to neutral voltage	
109		110		111		112	
Maximum Phase to neutral voltage		Minimum Phase to neutral voltage		Average Phase to neutral voltage		Instant Phase to phase voltage	
113		114		115		116	
Maximum Phase to phase voltage		Minimum Phase to phase voltage		Average Phase to phase voltage		Instant current of each phase	
117		118		119		120	
Maximum current of each phase		Minimum current of each phase		Average current of each phase		Max demand current of each phase	
121		122		123		124	
Instant active power of each phase		Maximum active power of each phase		Minimum active power of each phase		Average active power of each phase	

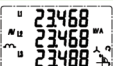
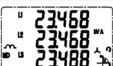
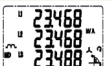
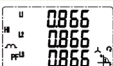
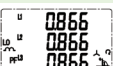
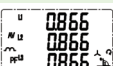
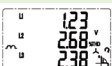
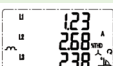
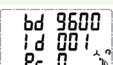
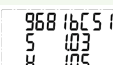
125		126		127		128	
Maximum demand active power of each phase		Instant reactive power of each phase		Maximum reactive power of each phase		Minimum reactive power of each phase	
129		130		131		132	
Average reactive power of each phase		Instant Apparent power of each phase		Maximum Apparent power of each phase		Minimum Apparent power of each phase	
133		134		135		136	
Average Apparent power of each phase		Maximum demand Apparent power of each phase		Instant power factor of each phase		Maximum power factor of each phase	
137		138		139		140	
Minimum power factor of each phase		Average power factor of each phase		Voltage THD		Current THD	
141		142					
Baud rate Modbus id Parity		CRC Software version Hardware version					

3.3 Change Default settings via buttons

After a long press (3 seconds) of the set button, the set-up screen will appear.

Steps :

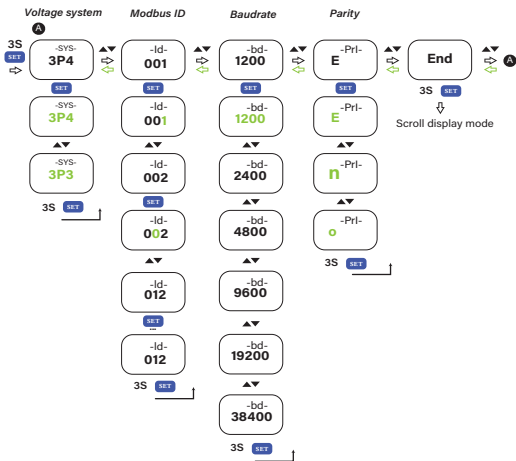

>> General	>> Unit	>> Default	>> Range
Modbus ID	/	001	001---254
Baud rate	bps	9600	1200---38400
Parity	/	None	None,Even,ODD
Type of wiring	/	3P4W	3P4W(Y) 3P3W(Δ)

» 4. Wiring diagrams

• 4.1 Voltage/Current terminals

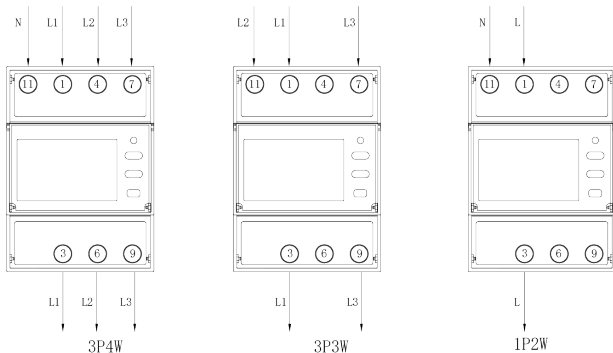

• 4.2 Other terminals

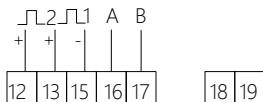

12&15	Programmable S02 pulse output (12+, 15-)
13&15	Active test pulse output S01 contact (13+, 15-)
16	RS485 communication contact RS485A
17	RS485 communication contact RS485B
18&19	Expandable to 5V power output (18+, 19-)

- 4.3 RS485 Wiring

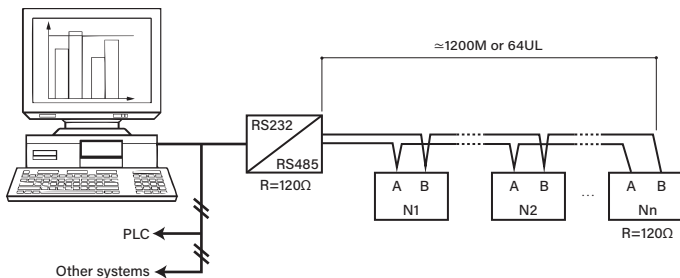

>> **5.Dimensions** (mm)

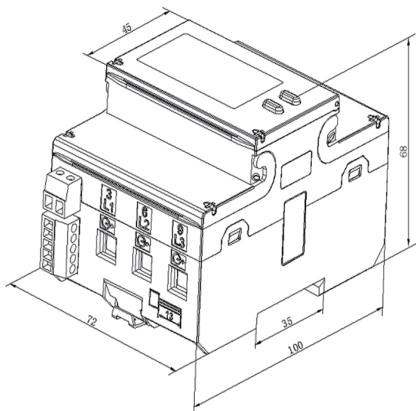

» 6. Available measurements

The following table shows the complete instrumentation functions of all OB4372 meters. Depending on the meter's setting all or a subset of the following functions are available.

» Active energy	» Unit	» System	» Phase
L1 import (+)	kWh+		●
L1 export (-)	kWh-		●
L2 import (+)	kWh+		●
L2 export (-)	kWh-		●
L3 import (+)	kWh+		●
L3 export (-)	kWh-		●
Import (+) Total	kWh+	●	
Export (-) total	kWh-	●	
Total	kWh	●	

» Reactive energy	» Unit	» System	» Phase
L1 import (+)	kvarh+	●	●
L1 export (-)	kvarh-	●	●
L2 import (+)	kvarh+	●	●
L2 export (-)	kvarh-	●	●
L3 import (+)	kvarh+	●	●
L3 export (-)	kvarh-	●	●
Import (+) Total	kvarh+	●	
Export (-) total	kvarh-	●	
Total	kvarh	●	

» Apparent energy	» Unit	» System	» Phase
Import (+)	kVAh+	●	
Export (-)	kVAh-	●	
Total	kVAh	●	

» Electrical variable	» Unit	» 3P4W	» 3P3W	» 1P2W
Voltage L-N	V	●		●
Voltage L-L	V	●	●	
Current L1	A	●	●	●
Current L2	A	●		
Current L3	A	●	●	
Current N	A	●		●
Current, Total	A	●	●	●
Active power, Total	kW	●	●	●
Active power, L1	kW	●	●	●
Active power, L2	kW	●		
Active power, L3	kW	●	●	
Reactive power, Total	kvar	●	●	●
Reactive power, L1	kvar	●	●	●
Reactive power, L2	kvar	●		
Reactive power, L3	kvar	●	●	
Apparent power, Total	kVA	●	●	●
Apparent power, L1	kVA	●	●	●
Apparent power, L2	kVA	●		
Apparent power, L3	kVA	●	●	
Power factor, Total	PF	●	●	●
Power factor, L1	PF	●	●	●
Power factor, L2	PF	●		
Power factor, L3	PF	●	●	
Frequency	Hz	●	●	●

» 7. Load survey/profile

The electric meter demand feature provides users with the capability to measure the highest electrical load within a chosen timeframe. With Modbus programmability, users can set recording intervals ranging from 1 to 256 minutes, offering flexibility in data collection. When configured with a 15-minute interval, the meter ensures a minimum of 42 days' worth of records, allowing users to analyse and manage electricity consumption effectively. This feature empowers users to tailor their monitoring preferences, gaining valuable insights into usage patterns and demand fluctuations for informed decision-making.

» 8. Pulse output (Terminals 12, 13 & 15)

The pulse output feature on your electricity meter allows you to monitor your energy consumption remotely and accurately. This section will guide you on how to use the pulse output terminals, which are labelled as 12 (Active Pulse), 13 (Programmable pulse) and 15 (Common), to access this valuable information.

• 8.1 What is Pulse Output?

The pulse output is a mechanism that generates electrical pulses at regular intervals to represent your electricity consumption. These pulses are typically used for remote calibration, monitoring, data collection, and billing purposes. Each pulse corresponds to a predefined amount of energy consumed, and by counting these pulses, you can track your electricity usage effectively.

» 9.Clean

- Preparation: Ensure the smart meter is disconnected or powered off to avoid any electrical hazards during the cleaning process.
- Exterior Cleaning: Use a soft, dry cloth to gently wipe the surface of the smart meter. For stubborn stains or dirt, lightly dampen the cloth with water or a mild detergent solution and carefully wipe the affected areas.
- Drying and Reconnection: After cleaning, ensure the smart meter is completely dry before reconnecting or powering it back on. Verify that all connections are secure and that the meter is functioning correctly.

» 10.Maintenance

Complying with the safety standards outlined in EN50470-3:2022, the OB4372 puts the safety of users and maintenance personnel first. For safe operation and maintenance, comprehensive safety information is provided in the maintenance manual. The location of the live parts in the smart meter is clearly indicated in the manual. These live parts can be accessed during maintenance activities, especially when the lid is removed. This information is crucial for maintenance personnel as it allows them to take the necessary precautions to avoid electric shock or any other accidents.

» 11.DC 5V output

Terminal 18 & 19 supply 5V DC Power output, 2 watts as appropriate for powering external communication devices.

» 12.Solar PV & Renewables

Import/export and generation metering are important features in three-phase energy metering systems. These features help monitor and record the flow of electricity in both directions (importing and exporting) and track the generation of electricity in renewable energy systems like solar or wind.

Example Configuration:

Import/Export Metering (Meter 1):

Import Metering: This feature measures the electricity consumed by a facility from the grid, commonly referred to as "importing" electricity. It tracks the total energy consumption in kilowatt-hours (kWh) or other units, allowing users to monitor their electricity usage accurately.

Export Metering: In cases where a facility generates excess electricity, such as from solar panels, wind turbines, or other sources, this feature measures the electricity sent back to the grid, known as "exporting" electricity. It tracks the total energy exported to the grid in kWh or other units.

Generation Metering (Meter 2):

Generation metering is a crucial feature for renewable energy systems. It measures the electricity generated by the facility's renewable energy sources, such as solar panels. This allows users to monitor their energy production, track the performance of their renewable energy system, and potentially receive incentives or feed-in tariffs for excess electricity fed back into the grid.

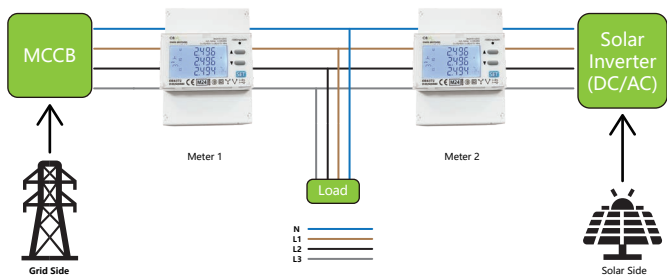

» 13. Technical support

Any questions, please contact:

TEL : 0044-161-6246211

Email : sales@owen-brothers.com